





THERMOSTATE THERMOSTATIC



NEW

ALEXIA

3639 S
36C300369

Thermostat Wafü- und Brause-
batterie mit Schwallauslauf und
integriertem Umsteller
Bathtub thermostatic without a
shower set



NEW

ALEXIA

3634 S
36D300370

Thermostat Brausebatterie

Thermostatic shower mixer
without shower kit



AROLA

2639S
226536

Thermostat Wannenfüll- und
Brausebatterie mit
Schwallauslauf und
integriertem Umsteller

Bathtub thermostatic kit - cas-
cade shower with integrated
diverter and without a shower set
.Chromme



AROLA

263402S
261873

Thermostat Brausebatterie

Thermostatic shower mixer with
integrated diverter without
shower kit. Chromme





KUATRO

4736 S

215304

Thermostat Wannenfüll- und Brausebatterie ohne Brauseset

Bathtub thermostatic kit - cascade shower with integrated diverter and without a shower set



KUATRO

4734 S

215295

Thermostat Brausebatterie

Thermostatic shower mixer without shower kit



RS-Q

9439 S

261649

Thermostat Wafü- und Brausebatterie mit Schwallauslauf und integriertem Umsteller

Bathtub thermostatic kit - cascade shower with integrated diverter and without a shower set



RS-Q

9434 S

261644

Thermostat Brausebatterie

Thermostatic shower mixer without shower kit



DRAKO

3339 S

219453

Thermostat Wannenfüll- und Brausebatterie und integriertem Umsteller

Thermostatic bath-shower mixer with integrated diverter in flow rate handle without shower set



DRAKO

333402 S

261885

Thermostat Brausebatterie

Thermostatic shower mixer without Drako shower set



RS-CROSS

6239 S

252699

Thermostat Wannenfüll- und Brausebatterie und integriertem Umsteller

Thermostatic bath-shower mixer with integrated diverter and no shower set.

442,6 €



RS-CROSS

623402 S

261899

Thermostat Brausebatterie

Thermostatic shower mixer without shower kit



1906 S

224007

Thermostat Wafü- und Brausebatterie ohne Brauseset

Thermostatic Bath and shower mixer without shower kit

Kartusche: 4760T + 1700C 1/2"
Cartridge: 4760T + 1700C 1/2"

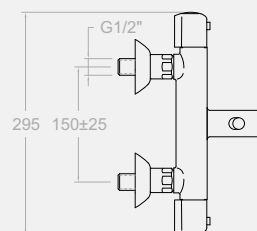
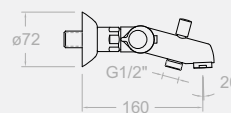



1906 T3

256758

Thermostat Wafü- und Brausebatterie mit Brauseset

Thermostatic Bath and shower mixer with shower kit



1906S + 5812 T3
Ref. 5812 T3 (5840 T3+3726+1128C)



1906 VM

226068

Thermostat Wafü- und Brausebatterie mit Brauseset

Thermostatic Bath and shower mixer with shower kit



1906S + 6554 VM
Ref. 6554 VM (3515+3546+1128C)



1904 S

223989

Thermostat Brausebatterie ohne Brauseset

Thermostatic shower mixer without shower kit

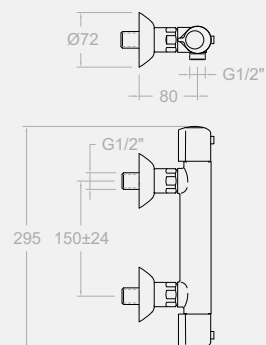

Kartusche: 4760T + 1700C 1/2"
Cartridge: 4760T + 1700C 1/2"



1904 T3

256776

Thermostat Brausebatterie mit Brauseset

Thermostatic Bath and shower mixer with shower kit



1904S + 5812 T3
Ref. 5812 T3 (5840 T3+3726+1128C)



1904 VM

226059

Thermostat Brausebatterie mit Brauseset

Thermostatic Bath and shower mixer with shower kit



1904S + 6554 VM
Ref. 6554 VM (3515+3546+1128C)



1994 T3

256767

Thermostat Brausebatterie mit Brauseset

Thermostatic shower column fixed height

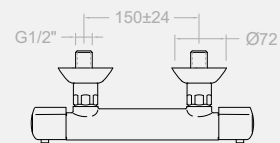
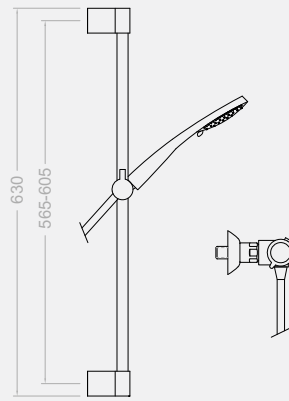

Kartusche: 4760T + 1700C 1/2

Cartridge: 4760T + 1700C 1/2

1904 S + 982402 T3

Ref: 982402 T3 (982402 S + 5840T3-1128C)



T300 RP240

256785

Thermostat Brausebatterie mit Brausestange und Antikalk-Regenbrause Ø240 mm (ABS), höhenverstellbar

Thermostatic shower column fixed height

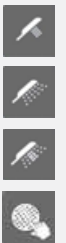
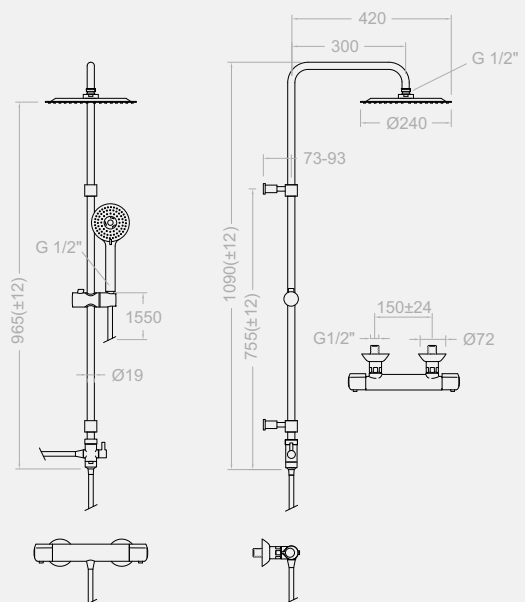



Kartusche: 4760T + 1700C 1/2

Cartridge: 4760T + 1700C 1/2

1904 S + T100N + RD-HDC+SFT+RP240+

5840 T3+1128C + 1129C

Thermostatkartusche Thermostatic cartridge 	4760T	217518	1904 y 1906	
Kartuschenmutter Cartridge nut 	TSC4760T	300065	1904 y 1906	
Luftsprudler Aerator 	1534	252879	1906	
Umsteller Diverter 	3375	217410	1906	
Rückflussverhin- derungsventil Check valve 	ARD 15	181680	1904 y 1906	
Stutzen f. Brauseschlauch- anschluss Shower raccord 	RDO4M (RDK)	224934	1904 y 1906	
Sitz Seat 	AGTI (AGT)	191418	1904 y 1906	
Mutter Seat nut 	T 3/4T	191400	1904 y 1906	
Zierblende Plate 	1325	167127	1904 y 1906	
	1330	203622	1904 y 1906 (Zierblende+ S-Anschluss/Pla- te+excentric)	
S-Anschluss Eccentric 	E1/2 3/4T	160257	1904 y 1906	
Brauseschlauch Flexible hose 	1128C	208176	1904 y 1906	
Keramikoberteil Ceramic head	1700C 1/2"	184308	1904 y 1906	

Griff Handles 	1950	224034	1904 y 1906 (Temperatur/ temperature)	
	1951	224043	1904 y 1906 (Durchfluss/ flow rate)	
Griff-Index Plug 	1961	224052	1904 y 1906	
Begrenzungsring Limiter rings 	ALK1	222621	1904 y 1906 (Temperatur/ temperature)	
	ALC3	227643	1904 y 1906 (Durchfluss/ flow rate)	